

RUSTIC & AUSTELL CERAMIC SINK

Installation Instructions & Aftercare Information



Due to our policy of continual improvement, we reserve the right to change specifications without prior notice.

U110657-02

Tools Required

Ruler/Tape Measure	Pencil or non-permanent marker
Masking Tape	Safety Glasses and Gloves
Kitchen Silicone Sealant	Screwdriver
Hammer	35mm Hole Saw (for cutting tap hole)
Drill	Jigsaw & Suitable Blade (if work top cutout is required)
4 mm masonry drill	Sharp ended nail punch
Half Round Tile File	

Fig. 1.1

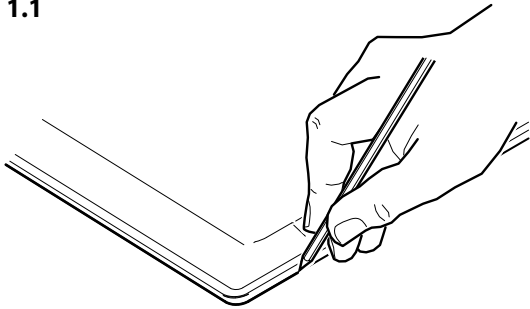

Fig. 1.2 Rustic

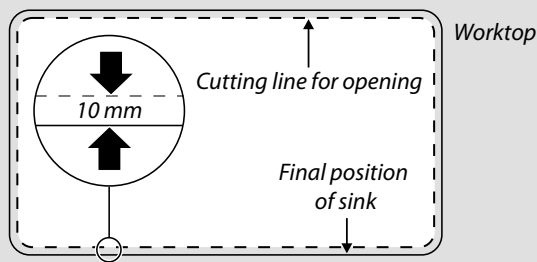

Fig. 1.3 Austell

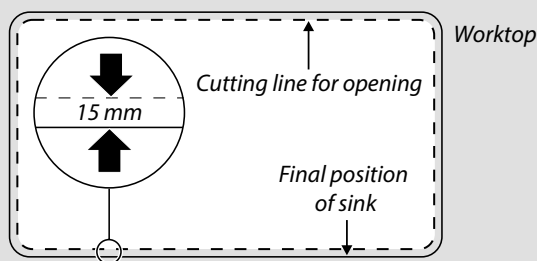
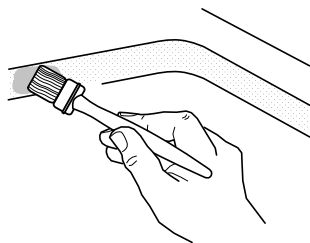

Fig. 1.4



Installer

Please leave this leaflet with the user, as it contains valuable after care advice. These instructions are applicable to both Left Hand and Right Hand Drainer sinks

Notes

- ⚠** During installation, take care to protect the sink from scuffs and scratches.
- ⚠** Do not stand on the sink.
- ⚠** During installation, do not stand the sink on its edges or corners. This may cause damage.
- ⚠** Avoid straining and over tightening of all plumbing fixtures connected to the sink.
- ⚠** Carefully check that the moulding and edges of the sink are dead level so that water will flow off the drainer.

Preparing the Worktop

Marking out the opening

We recommend that you fit the sink to the worktop before permanently fixing the worktop to the cabinet.

Decide the approximate position your sink is to be fitted, paying particular attention to where the taphole is to be fitted and proceed to cut your worktop and install your ceramic sink as follows:

1. Place the sink upside down on the worktop. Position the sink on the worktop as required. Make sure the cabinet framework will clear all parts of the sink. Using a soft, sharp pencil draw around the sink as accurately as possible (**Fig. 1.1**). Remove the sink and check that the marked dimensions are the same as your sink.
2. For Rustic ceramic sinks installation, draw another line 10mm inside the sink top outline - this is the cutting line for the opening (**Fig. 1.2**).
3. For Austell ceramic sinks installation, draw another line 15mm inside the sink top outline - this is the cutting line for the opening (**Fig. 1.3**).
4. Drill as large a hole as possible inside the cutting line. Using a pad saw, jigsaw or similar, cut out the opening up to the cutting line.
5. Check that the sink fits in the cut-out, if it does not fit perfectly, some localised enlargement of the hole may be necessary.

Sealing the edges of the opening

We recommend that porous edges around the cut-out are sealed using a waterproof sealant such as varnish, paint or wood glue. This will prevent swelling of the worktop should any small leaks occur (**Fig. 1.4**).

Preparing the Tap hole

- ⚠ **It is highly recommended that safety goggles and gloves are worn when knocking through the tap hole.**
- ⚠ **We DO NOT recommend creating additional tap holes. Damage to the sink from attempting to create further tap holes will not be covered under warranty.**

1. Choose the tap hole position based on the bowl and drainer orientation. This may be achieved by turning the sink upside down onto a suitable flat, well supported and protective surface. You will see a 35 mm part depth hole on either side of the sink. These are the tap holes.
2. After double-checking that you have chosen the correct tap position, you can begin work on creating the tap hole. Drill a 4 mm hole with your masonry drill through the centre of the part removed hole with minimum force **Fig. 2.1**.

⚠ DO NOT USE HAMMER ACTION.

3. After removing any debris from where you just drilled, carefully turn the sink over. Continue to use a strong, stable surface to support the drainer to allow further work.
4. Now working from the top face, place the template in the centre of the 4 mm tap hole. Use a pencil or non-permanent marker to mark through the 35 mm perimeter ring.
5. Place the sharp-ended nail in the centre of the 4 mm hole. Using a hammer strike firmly the top of the punch until it has broken through. Work around the outer edge of the hole, with small repeated blows. Slowly increase the size of the hole until a round or half-round tile file can be inserted **Fig. 2.2**.
6. Carefully file away the remaining material to gradually enlarge the tap hole until you have removed the entire 35 mm part-depth hole. Clear away any debris **Fig. 2.3**.

Applying the Silicon Sealant

- ⚠ **DO NOT use Epoxi sealant or Epoxi adhesive.**
 - ⚠ **Silicone sealant may contain irritants and it is therefore advised the suitable Personal Protective Equipment is worn e.g. light weight rubber gloves, when the sink is sealed to the worktop.**
1. If possible, it is best practice to have the tap installed, prior to sealing the sink to the worktop.
 2. Apply a bead of "kitchen silicone sealant" (not included) to the underside of the sink flange **Fig. 2.4**. Carefully position the sink into the worktop opening.
 3. You may choose to neatly seal around the sink outer perimeter using the silicone. Whilst the underside channel silicone bead should provide a watertight seal we recommend this step out of prudence. Remove any surplus silicone sealant with a wet finger.

Waste Fittings

Fit the waste fittings to the sink using the instructions supplied with them.

- ⚠ **Do not overtighten waste outlets, pipework or taps as this may crack/chip the enamel surface**

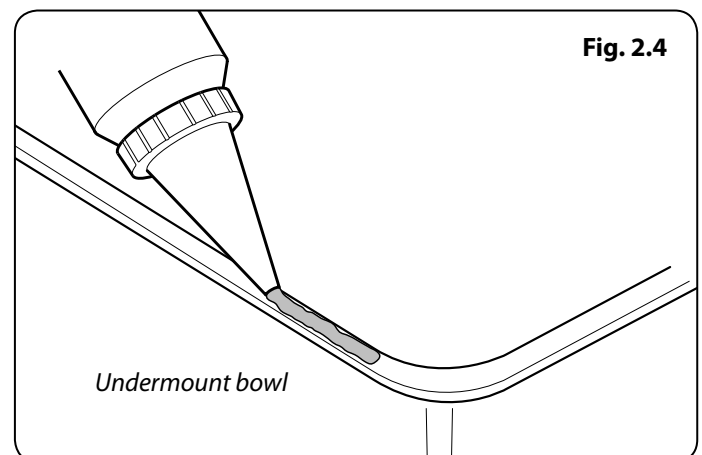
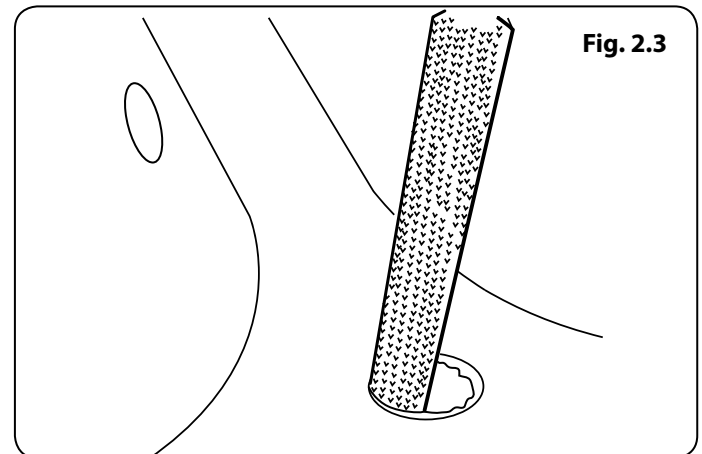
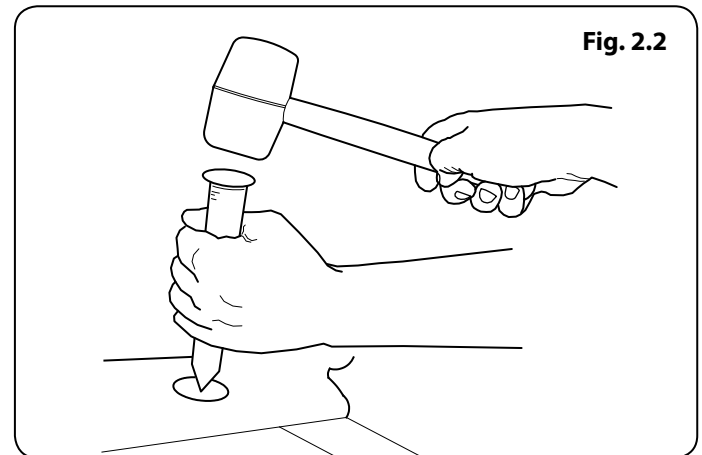
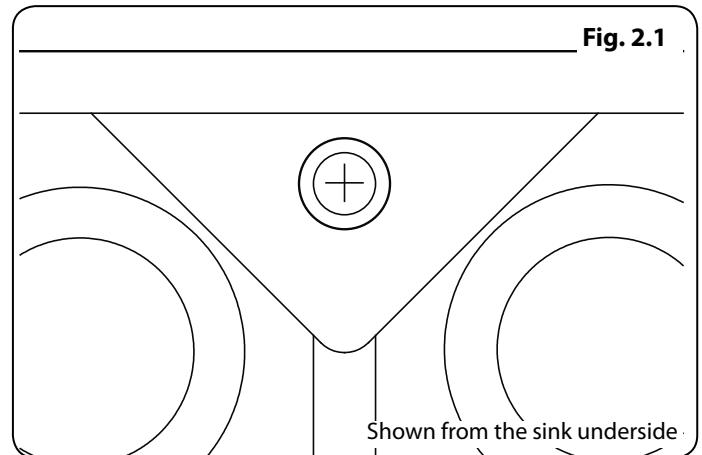

10 YEAR GUARANTEE

We guarantee to replace any ceramic sink that breaks due to material or manufacturing defects within 10 years from the date of purchase.

The guarantee does not cover normal wear and tear occurring through use of the product.

For the guarantee to apply the owner must follow the use, care and cleaning instructions provided.

Accessories and waste fittings are not included in this guarantee.



RANGEmaster

Meadow Lane, Long Eaton,
Nottingham, NG10 2GD, England
Tel: +44 (0) 115 946 4000 Fax: +44 (0) 115 973 6602
E-mail: consumers@agarangemaster.co.uk
www.rangemaster.co.uk

17

Kitchen sink made of: Ceramic
Preparation of food, washing of dishes and
discharge of domestic waste water
EN 13310 : 2015
CA - DA

Check for Leaks:

- Supply user tubes to faucet.
- Supply riser tubes to shut off valves or lower connections.
- Fill sink with water and check for leak around drain.
- Release water from sink and check for possible leaks.

After Care

Day-to-day care

Although your sink is made from extremely durable materials and will withstand a great deal of hard use, it can be scratched by hard or sharp objects. If the surfaces are to be kept in a blemish free condition reasonable care should be taken when handling such items.

▲ DO NOT USE THE DRAINER AS A CHOPPING BOARD.

Cleaning

Never use any form of abrasive cleaner or applicator. Such cleaners contain sand or silica and will eventually scratch the surface. The best way in our experience to keep your sparkling enamel surface is to apply a dilute solution of bleach every 2 or 3 days. Apply with a sponge or soft kitchen cloth and rinse the sink surface thoroughly with plenty of water. Not only will it make the surface shine but will also keep the sink hygienic.

NOTE: Bleach can be harmful both orally and on your clothes and skin so always wear rubber gloves and ensure you rinse.

Ensure proper ventilation as bleach gives off strong fumes.

CARE: The Gloss surface of the sink is susceptible to damage from sharp and metallic objects. The worst offender is metal cutlery. Try to avoid metal objects coming in contact with the surface by using protective plastic bowls, cutler holders and drainers with non-abrasive bases.

▲ Please do not over tighten any fittings as this may cause the surface of your ceramic sink to crack.

Please refer to www.rangemaster.co.uk for a full guide to cleaning your sink.

Due to our policy of continual improvement, we reserve the right to change specifications without prior notice.