

MAYON IGNEOUS/GRANITE INSET SINK MAY1051DG/

RANGEmaster
sinks & taps



Size: 1000 x 510 mm

Featuring sharp geometric bowls and a smooth drainer design, the Mayon range also features a sleek chrome branded overflow cover adding a premium finish to the overall sink design. The Mayon range is composed of 3 options; single bowl in standard and ultra compact sizes and a 1.5 bowl option.

- Igneous granite
- Reversible drainer
- Waste kit included
- 25 year warranty

Material	Igneous/Granite
Material Gauge	-
Material Finish Bowl	-
Material Finish Drainer	-
Drainer Position	Reversible
Overall Length (mm)	1000
Overall Width (mm)	510
Main Bowl Length (mm)	500
Main Bowl Width (mm)	446
Main Bowl Depth (mm)	195
Second Bowl Length (mm)	-
Second Bowl Width (mm)	-
Second Bowl Depth (mm)	-
Tap hole Size (mm)	-
Waste Size (mm)	1 x 89
Waste Kit:	Included with sink (1 x 89mm BSW & overflow kit)
Min. Base Unit (mm)	600
Cutout Size Length (mm)	980
Cutout Size Width (mm)	490
Warranty (years)	25
Product Code	MAY1051DG/
Barcode	5015834050584

Date of download: February 20, 2021

AGA Rangemaster continuously seeks improvements in specification, design and production of products and thus, alterations take place periodically. Whilst every effort is made to produce up to date resources, the information included here is intended as a guide. Always refer to the installation instructions when fitting, installation work should be completed by a professional tradesman.

MAYON IGNEOUS/GRANITE INSET SINK

MAY1051DG/

Technical Drawing

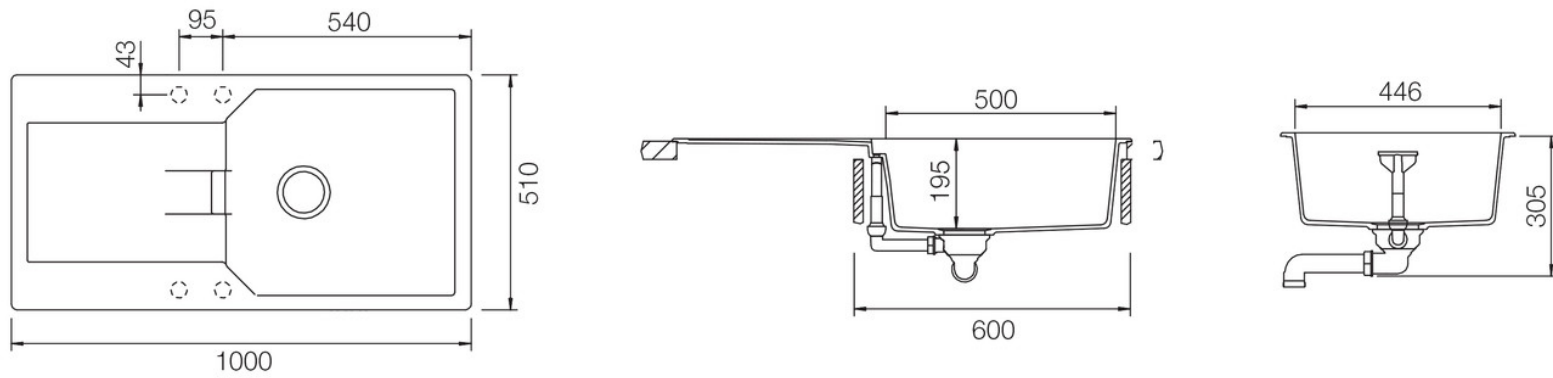

Date of download: February 20, 2021

AGA Rangemaster continuously seeks improvements in specification, design and production of products and thus, alterations take place periodically. Whilst every effort is made to produce up to date resources, the information included here is intended as a guide. Always refer to the installation instructions when fitting, installation work should be completed by a professional tradesman.

MAYON IGNEOUS/GRANITE INSET SINK

MAY1051DG/

Cut Out Template
Dimensions in mm. Not to scale.

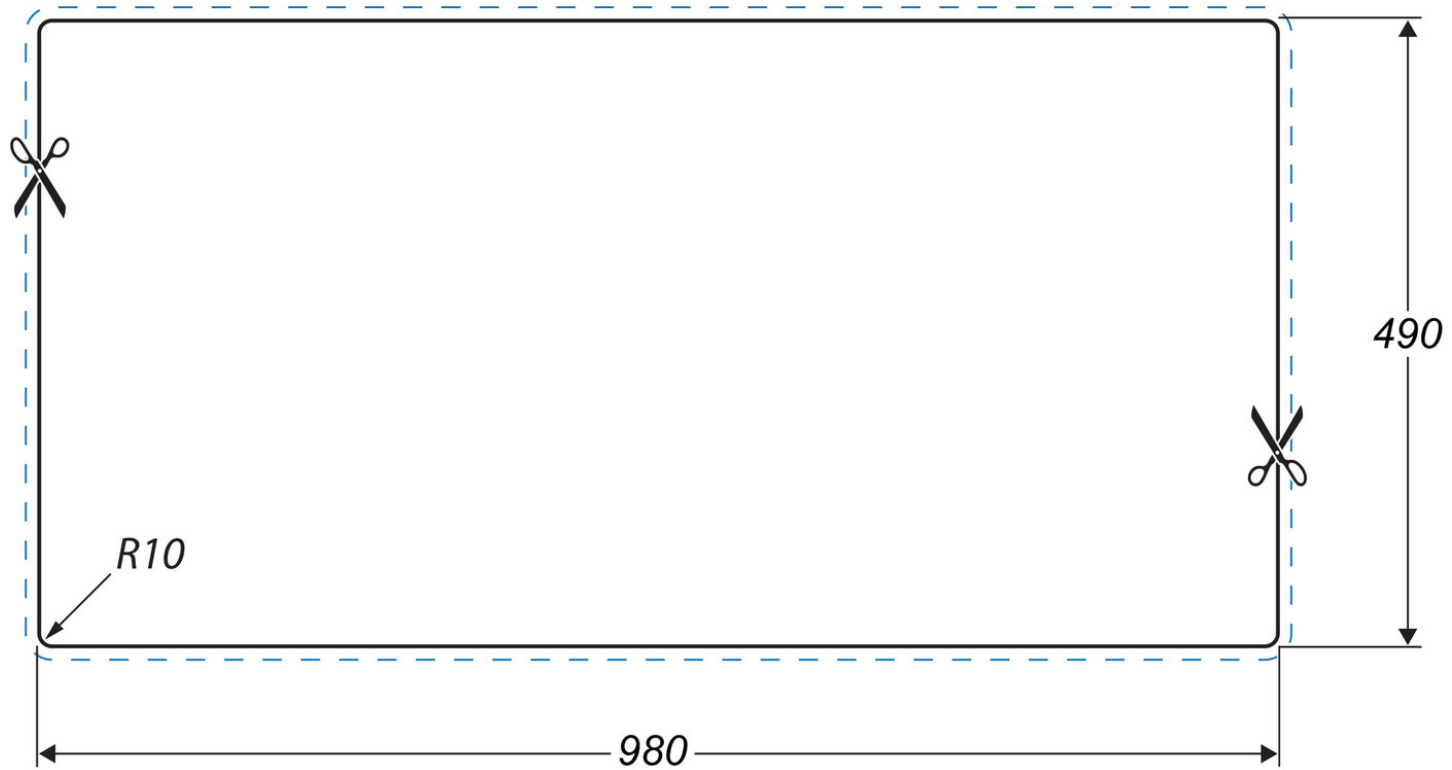

Date of download: February 20, 2021

AGA Rangemaster continuously seeks improvements in specification, design and production of products and thus, alterations take place periodically. Whilst every effort is made to produce up to date resources, the information included here is intended as a guide. Always refer to the installation instructions when fitting, installation work should be completed by a professional tradesman.